

 **CIRCLE SEAL CONTROLS, INC.**
A division of CIRCOR International, Inc.

1000, 3000 & 4000 SERIES BIVCO CHECK VALVES

Operating Characteristics

- **VERSATILITY** BIVCO valves may be used in either liquid or gas systems.
- **NO LEAKAGE** Bubble-tight sealing is provided even at very low-pressure differentials.
- **FAST RESPONSE** The poppet design, which is light in weight and functions as "sail", is acted upon by fluid in the system to cause rapid and full opening of the valve regardless of installed position.
- **DEPENDABILITY** The use of Teflon® or other high performance plastic materials provides resiliency to shock and long life under various conditions.
- **LOW PRESSURE DROP** Large passageways provide flow characteristics with lower pressure drop than competing valves.
- **NON-STICKING** The free-floating seat and poppet design prevents sticking due to canting of the disk member. Teflon® used in seats and poppets is self-lubricating and resistant to corrosion.
- **NOISE FREE** Chatter due to pulsation in the fluid system is absorbed by the resilient materials and unique design of the seat and poppet.
- **ADAPTABLE TO MOST FLUIDS** Standard Bronze, Brass, Steel, and Stainless Steel valves with Teflon® seats and poppets are suitable for a wide range of fluids. Valves with bodies of Teflon® are BIVCO specialties for corrosive fluids.

NOTE: Proper filtration is recommended to prevent damage to sealing surfaces.

How It Works

The BIVCO Floating Seat and Poppet

The operating principles of BIVCO valves are unique. The conical seat of Teflon® or other high performance plastic fits loosely when snapped in place and then becomes free floating, permitting horizontal, vertical and radial movement. In the closed position, the wedge-like action of the conical poppet seals the seat against the body, assuring positive, bubble-tight sealing. In the open position, the seat again becomes free floating.

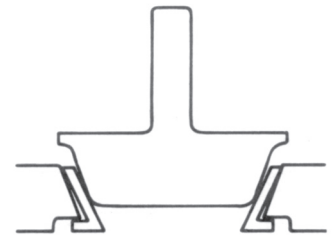

Poppet Making Contact with Seat

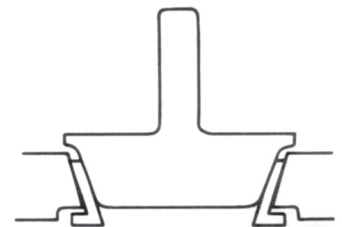

Poppet in Closed Position

2301 Wardlow Circle, P.O. Box 3300
Corona, California 92878
tel 909.270.6200
fax 909.270.6201
www.circle-seal.com
sales@circle-seal.com

1000, 3000 & 4000 SERIES BIVCO CHECK VALVES

LIFT TYPE - 1000 SERIES

Bodies of Cast Bronze or Stainless Steel

DESCRIPTION

BIVCO 1000 Series are highly reliable lift type models which provide positive, zero leakage sealing and low-pressure drop. The standard model has NPT Female end connections. Other models are available including configurations with socket ends for welding or soldering to pipe, and with flanged ends. All models are normally supplied with light springs for nominal 0.5 psi cracking pressure. Valves may be ordered with no spring or with springs in a range of cracking pressures.

SPECIAL FEATURES

Large seating areas provide very sensitive opening pressures and fast response. Seats, poppets and o-rings are easily replaced. Poppet is backstopped by a guide to prevent overstressing spring. Operation is chatter-free.

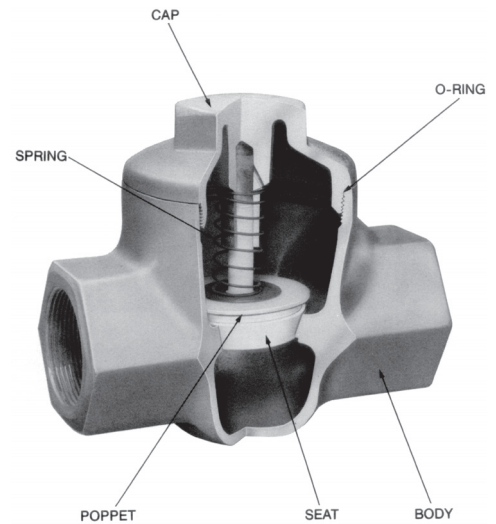

IN-LINE TYPE - 3000 / 4000 SERIES

Bodies of Machined Bar Stock

DESCRIPTION

BIVCO 3000 / 4000 Series of check valve models are designed to work with the same floating seats and poppets as the 1000 Series. The standard model has NPT Female end connections. Other models are available, including configurations with socket ends for welding or soldering to pipe, and with flanged ends. All models are normally supplied with light springs for nominal 0.5 psi cracking pressures. Valves may be ordered with no spring or with springs in a range of cracking pressure. Standard body materials are Brass, Stainless Steel, and Carbon Steel. See "How to Order" chart.

SPECIAL FEATURES

Large seating areas provide sensitivity and fast response. In-line models exhibit extremely low-pressure drop and can be truly called full flow valves. Poppet is backstopped by a guide to prevent overstressing the spring. Operation is chatter-free.

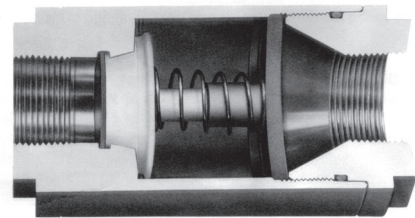
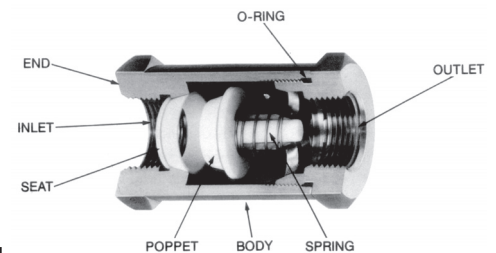

1000, 3000 & 4000 SERIES BIVCO CHECK VALVES

How to Order

1000 SERIES PART NUMBER DESIGNATION

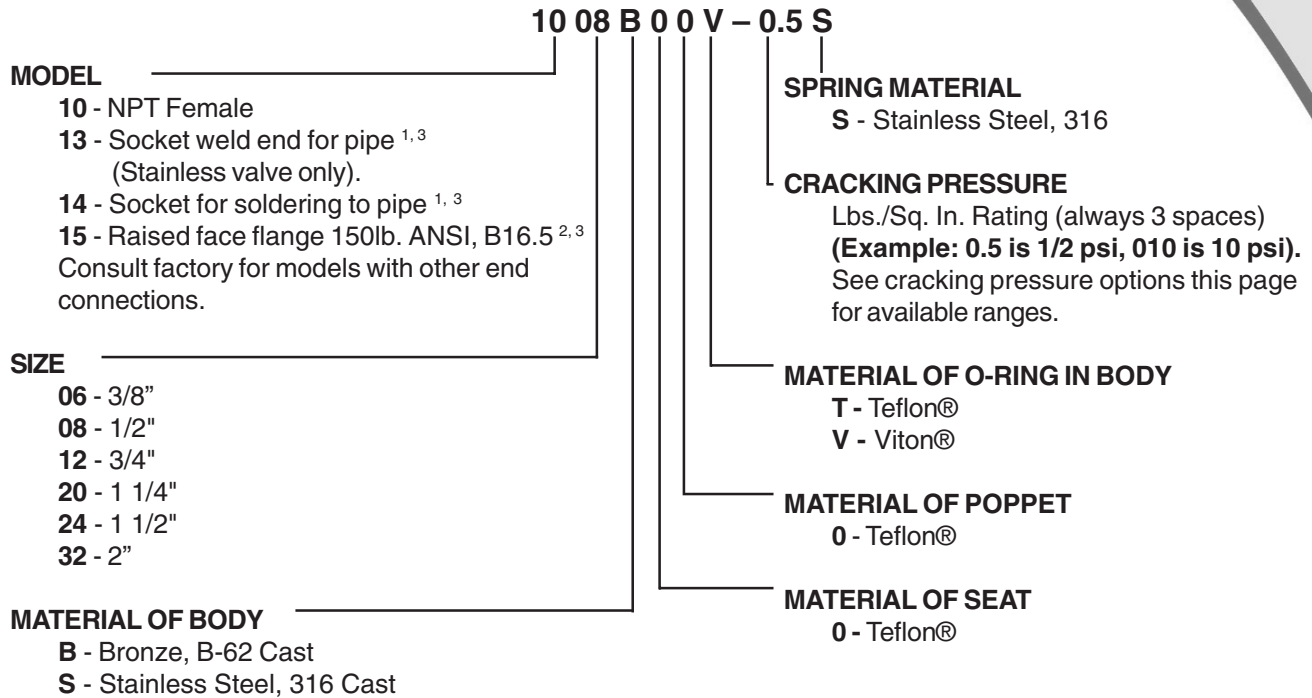

NOTES

- ¹ Dimensions of socket ends are available on request.
- ² Model with raised face 150lbs. Flange is available to special order in sizes 3/4" through 2" in bronze or Stainless Steel. Dimensions supplied on request.
- ³ 10 piece minimum order required.

*Viton® is a registered trademark of DuPont Dow Elastomers.
Teflon® is a registered trademark of the DuPont Company.*

For Your Safety

It is the sole responsibility of the system designer and user to select products suitable for their specific application requirements and to ensure proper installation, operation and maintenance of these products. Material compatibility product ratings and application details should be considered in the selection. Improper selection or use of products described herein can cause personal injury or property damage.

PSIG CRACKING PRESSURE OPTIONS/RANGES FOR THE 1000 SERIES

CRACKING PRESSURE							
PART NO.	-0.5	-002	-004	-006	-008	-010	NOMINAL ←
1000 SERIES	1.0	2.6	5.2	7.7	10.3	13.0	MAX.
	0.2	1.6	3.2	4.8	6.4	7.8	MIN.

Replacement Parts

In normal service the only parts which may require replacement are the seat, poppet and o-ring. A complete repair kit may be ordered, specify kit followed by the complete valve part number.

1000, 3000 & 4000 SERIES BIVCO CHECK VALVES

How to Order

3000 & 4000 SERIES PART NUMBER DESIGNATION

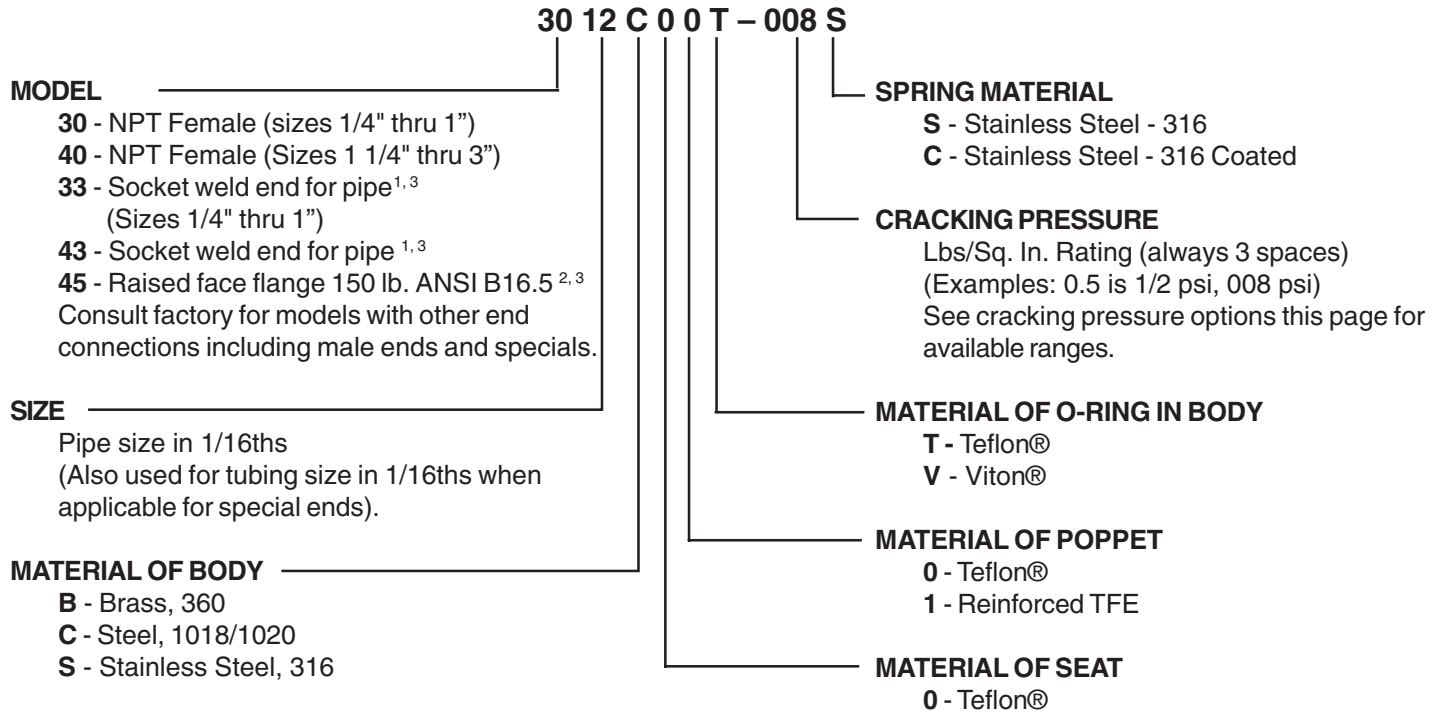

NOTES

- ¹ Dimensions of socket ends are available on request.
- ² Model with raised face flange is available to special order. Flange is slip-on type welded to nipple in socket weld end of valve. Dimensions supplied on request.
- ³ 10 piece minimum order required, sizes 1 inch and above.
- ⁴ For Model 4048, consult factory.

*Viton® is a registered trademark of DuPont Dow Elastomers.
 Teflon® is a registered trademark of the DuPont Company.*

PSIG CRACKING PRESSURE OPTIONS/RANGES FOR 3000 AND 4000 SERIES

CRACKING PRESSURE

PART NO.	-0.5	-002	-004	-006	-008	-010	NOMINAL ←
3000 & 4000 SERIES	1.0	2.7	5.3	7.9	10.5	13.2	MAX.
	0.2	1.6	3.1	4.8	6.4	8.0	MIN.

Replacement Parts

In normal service the only parts which may require replacement are the seat, poppet and o-ring. A complete repair kit may be ordered, specify kit followed by the complete valve part number.

1000, 3000 & 4000 SERIES BIVCO CHECK VALVES

Dimensions (inches), Technical Data & C_v Ratings

MODEL 1000 SERIES LIFT CHECK - BRONZE						
Part No.	Size	A Length	B Hex	C Dia.	D	C _v * (Nominal)
1006	3/8	2 5/16	1	1 5/8	1 5/8	2.75
1008	1/2	2 3/4	1 1/8	1 15/16	1 13/16	4.37
1012	3/4	3 1/2	1 3/8	2 11/16	2 5/16	8.40
1016	1	4 5/8	1 3/4	3 1/16	2 13/16	12.76
1020	1 1/4	5 3/4	2 1/4	3 9/16	3 5/8	16.70
1024	1 1/2	6 1/4	2 1/2	4 1/16	3 3/8	21.77
1032	2	7 1/2	3	4 9/16	4 1/2	32.02

1000 Series

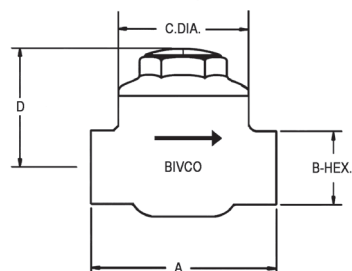

MODEL 1000 SERIES LIFT CHECK - CRES 316						
Part No.	Size	A Length	B Hex	C Dia.	D	C _v * (Nominal)
1008	1/2	4	1 3/8	2 3/4	2 3/8	4.37
1012	3/4	4	1 3/8	2 3/4	2 3/8	8.40
1016	1	4 5/8	1 3/4	3 1/16	2 13/16	12.76
1020	1 1/4	5 3/4	2 1/4	3 9/16	3 5/8	16.70
1024	1 1/2	6 1/4	2 1/2	4 1/16	3 3/8	21.77
1032	2	7 1/2	3	4 9/16	4 9/16	32.02

3000, 4000 Series

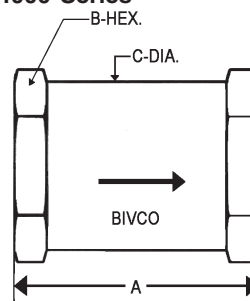

3000 SERIES IN-LINE					
Part No.	Size	A Length	B Hex	C Dia.	C _v * (Nominal)
1008	1/2	4	1 3/8	2 3/4	4.37
1012	3/4	4	1 3/8	2 3/4	8.40
1016	1	4 5/8	1 3/4	3 1/16	12.76
1020	1 1/4	5 3/4	2 1/4	3 9/16	16.70
1024	1 1/2	6 1/4	2 1/2	4 1/16	21.77
1032	2	7 1/2	3	4 9/16	32.02

4000 SERIES IN-LINE					
Part No.	Size	A Length	B Hex	C Dia.	C _v * (Nominal)
4020	1 1/4	6	3	3 1/2	35.00
4024	1 1/2	6	3	3 1/2	36.50
4032	2	6 9/16	3 1/2	4	51.15
4048	3	10 3/16	5 1/4	6 1/2	70.05

* Flow coefficient (C_v) with standard 0.5 psi spring

OPERATING PRESSURE RANGE
1000, 3000, AND 4000 SERIES @ 70° F
(See Temperature Derating Table)

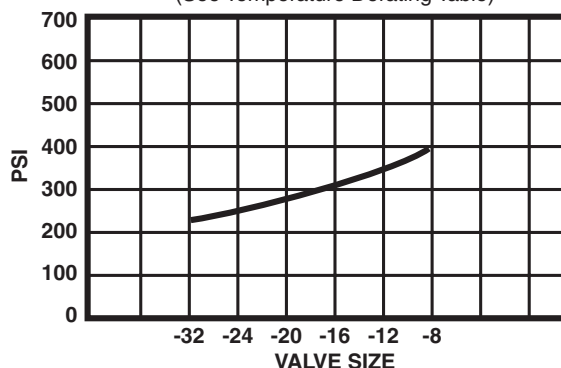

Note: Pressure in reverse direction limited to 120 psi.

Temperature derating factor "K" for max allowable reverse pressure at given ambient and/or media temperature

Deg. F	73	150	212	250
"K" Teflon®	1.0	0.65	0.17	0.34

1000, 3000 & 4000 SERIES BIVCO CHECK VALVES

BIVCO Valve Applications

Besides check and valve functions, all purpose BIVCO valves are designed for pressurizing, vacuum breaking or holding, positive shutoff, antisiphoning, back flow protection and foot-valve operations.

Successful applications of BIVCO valves include the following industrial processes:

Chemical processing
Metallurgical processing
Photographic filmmaking
Nuclear power
Water purification
Steam heating systems
Pharmaceutical processing
Research laboratories
Gas compression
Food processing
Plastics manufacturing
Naval ships instrumentation
Oil / water separation
Paper making
Chlorine battery development
Beverage bottling equipment
Plating processed
Missile systems
Fuel handling
Distillation processes
Refrigerant handling
Original equipment manufacturing

BIVCO valves are considered all-purpose valves because they can be tailored in the right combination of materials for the job at hand...for liquids, including acids, alkalis, formaldehyde, solvents, oils, gasoline, water, sea water, deionized water, pharmaceutical liquids, steam condensates, refrigerants...for gases including air, oxygen, argon, helium, nitrogen, dry chlorine, sulphur dioxide...for vapors including saturated steam, wet chlorine, and various others.

Applications by Valve Type and Series

BIVCO Lift Type 1000 Series

- Check valve in oxygen and air line downstream of control valve
- Check valve for process gas
- Check valves in nitrogen lines, subject to radiation
- Vacuum breakers in vapor system of water desalinization equipment
- Check valves for steam condensate, temperature 180°–200° F
- Air vent and liquid flow control valves in oil-water separation

BIVCO In-line Type 3000 / 4000 Series

- Check valve in hydrofluoric acid feed line.
- Check valve for steam to prevent back flow of caustic materials
- Check valve for use in dry chlorine service
- Check valve for service in formic acid and formaldehyde
- Check valve in chlorine purge rotometer line
- Check valve in packaging equipment for precise metering of pharmaceutical liquids
- Check valve between stages of rotary air compressor
- Check valve in caustic soda and water system for cleaning pipes in milk plant
- Check valve for hot caustic liquor
- Check valve in air line to prevent back flow of carbonated beverage
- Check valves in steam system for return condensation, chlorine present